

Owner's Manual

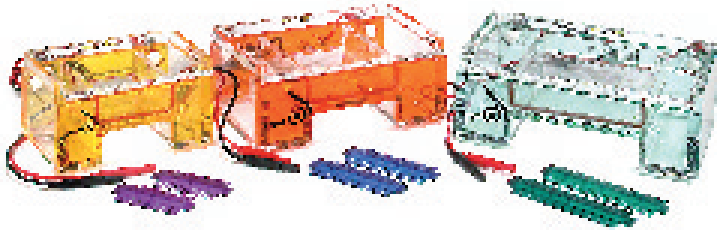

EasyCast™ Horizontal System

Models B1A, B1, and B2

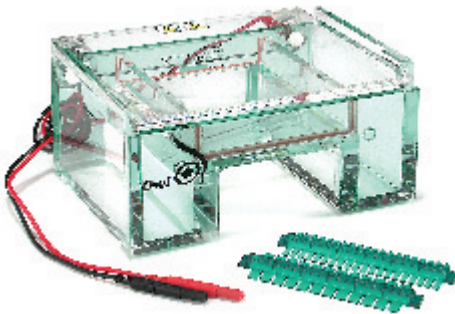

The Buffer Puffer™ Horizontal System

Model B3

Important Safety Information!

Please read carefully before operating!



• This manual contains important operating and safety information. In order to benefit from the use of this apparatus, you must carefully read and understand the contents of this manual prior to use of this apparatus.



• To avoid the risk of personal shock, always disconnect the gel box from the power supply. Further, the power supply must be equipped with a shut-down-on-disconnect circuit.

- Statement of Proper Use: Use this product only for its intended purpose as described in this manual. Do not use this product if the power leads are damaged or if any of its surfaces are cracked.*
- Running conditions for this unit should not exceed the name plate readings found on the lower buffer chamber.*
- Do not move the unit unless the power source to the unit has been disconnected.*
- This Owl System is designed to meet IEC 1010-1 safety standards (IEC 1010-1 is an internationally accepted electrical safety standard for laboratory instruments).*

Table of Contents

Section 1 General Information	2
Unpacking and Checking Your Order	3
B1A, B1 & B2 Parts List	3
B3 Parts List	4
Section 2 Setting Up	5
Preparing the Gel	6
Migration Distance	7
Section 3 Using the System	8
Loading the Sample	8
B3 Buffer Puffer™ Self Recirculation System	10
Section 4 Finishing Up	11
Section 5 Technical Tips	12
Running a Standard Ladder	12
Comb Options	12
Why Recirculate Buffer?	15
Sample Well/Comb Configuration	15
Reagent Information	16
Section 6 Troubleshooting	19
Section 7 Care & Cleaning	22
A Few Tips About Caring for Your System	22
Care of Acrylic	23
Section 8 Optional Equipment	24
Multiple Gel Caster	24
Optional Multi-Load Tray & Combs	24
Buffer Exchange Port Option.....	24
Leveling Tray	25
Replacement Parts	25
Comb Options	27

INTRODUCTION

The Owl **EasyCast™** Horizontal Minigel Systems, Models B1A, B1, and B2, are designed to provide flat, even banding patterns and consistent results with hassle-free gel casting. The all-in-one design allows you to cast and run gels in the same chamber, eliminating the need for additional casting equipment. No tape, grease, agarose seals or other accessories are required. All EasyCast systems accommodate 2 comb positions, allowing the user to run 2 series of samples equal distances simultaneously. Convenient visualization strips have been added for easier sample loading; and fluorescent ruled UVT gel tray helps in the precise photodocumentation of each gel run. Three gel sizes are available for increased sample capacity and running length. Stand-alone casting platforms are available for pouring up to 3 gels simultaneously while the chamber is in use. Owl offers a wide variety of combs, including options that can double your sample capacity by doubling the number of sample wells, preparative combs, and wall combs to run gels in smaller sizes. Custom combs are also available.

The Model B3 Buffer Puffer™ recirculation system offers convenience and versatility. The Buffer Puffer™ recirculation system prevents formation of pH and ionic gradients for high resolution and uniform reproducible results. The Buffer Puffer™ is ideal for long runs, multiple sample sets or RNA gels. The Buffer Puffer™ delivers clear results for samples run over long time periods. It also eliminates uneven migration, band distortion or disassociation of pH dependent glyoxylated RNA molecules that can result when ionic depletion occurs. Because the recirculation system is built right into the buffer chamber, no external pumps, tubing or stir bars are required.

UNPACK & CHECK YOUR ORDER

Before starting, unpack the unit and inventory your order. If any parts are missing, refer to the warranty section of this manual and contact Owl within 7 days of purchase at 800-242-5560.

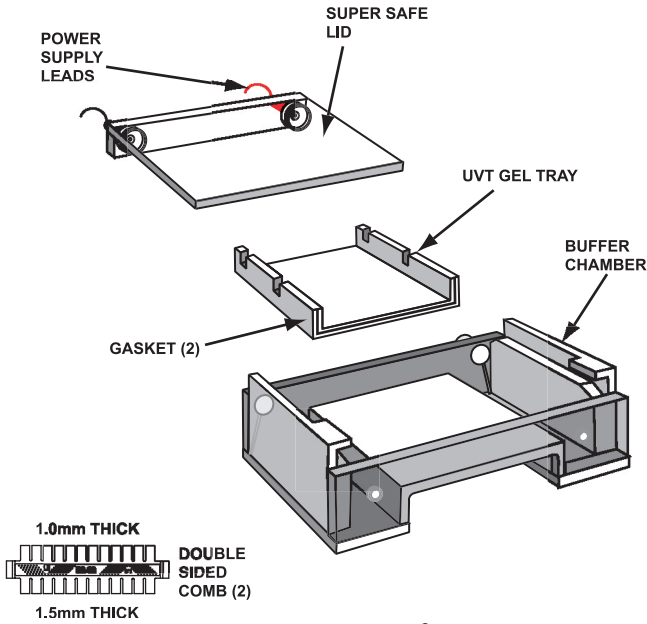

B1A, B1 & B2 Parts Diagram

B1A, B1 & B2 Parts List

- Buffer Chamber
- Combs: (2) 1.0/1.5mm Thick, Double Sided
- Super Safe™ Lid with attached Power Supply Leads (2)
- Gasketed EasyCast™ UV Transmissible (UVT) gel tray

See page 25 for replacement parts for Model B1A

See page 27 for optional combs for Model B1

See page 28 for optional combs for Model B2

Specifications and Recommended Running Conditions

Model	B1A	B1	B2
Gel Size (W x L in cm.)	7x8	9X11	12x14
Buffer Capacity	400ML	600ML	800ML
Time Requirements (minutes)	30-60	45-90	60-120
Voltage Requirements (V)	20-150	20-150	20-150

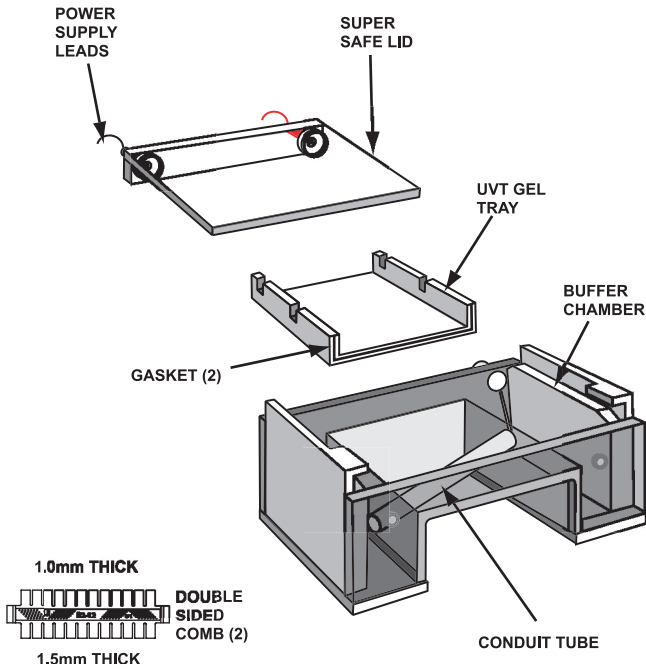

B3 Parts Diagram

B3 Parts List

- Buffer Chamber
- (2) Combs: 1.0/1.5mm Thick, Double Sided
- Super Safe™ Lid with attached Power Supply Leads (2)
- Gasketed EasyCast™ UV Transmissible (UVT) gel tray

See page 25 for replacement parts for Model B3

See page 27 for optional combs for Model B3

Model	B3
Gel Size (W x L in cm.)	12X14
Buffer Capacity	100ML
Time Requirements (min.)	60-120
Voltage Requirements (V)	20-150

STEP 1

Remove the SuperSafe™ lid from the buffer chamber. The SuperSafe™ Lid is attached to the back of the unit at the junction of the lid's attached power supply leads to the banana plugs located on the unit. To remove hold the front of the buffer chamber with one hand and pull the lid off; sliding it off evenly by holding the center of the back of the lid.

STEP 2

For shipping and convenient storage, the gel trays are packaged inside the casting chamber. To remove the gel trays, hold the casting chamber firmly with one hand; grasp the long sides of the UVT gel tray and pull up slowly at an angle with your other hand. The trays fit snugly for leak proof gel casting; therefore they may be tight. "Walking" the tray upwards at an angle may be helpful. The tightness will diminish the more the unit is used.

STEP 3

To cast gels, place the UVT gel tray into the buffer chamber in the casting position (see page 9) making sure the gel tray rests level and centered on the platform. Be sure the gasketed ends of the gel tray press against the walls of the buffer chamber. Owl offers a leveling platform, catalog no. B-LP, page 25, if needed.



STEP 4

Preparing the gel - Using electrophoresis-grade agarose and compatible electrophoresis buffer, the gel may be prepared in various ways. The percentage of agarose and the electrophoretic buffer used is determined by the size of the samples to be separated and further recovery of the samples (see Table 5-1, page 16). The agarose and buffer are mixed and heated over a heat source, in a microwave oven, or in an autoclave until the agarose is completely dissolved. The prepared gel then must be cooled to below 60°C before casting to avoid warping the UVT gel tray, due to excessive heat. If numerous gels are to be run in one day, a large volume of gel may be prepared and placed in a covered bottle stored between 40-60°C in a water bath. This provides a ready gel supply in a warm liquid form that will solidify quickly when gels are cast. For further tips on sample preparation and visualization, see Table 5-1, page 16.

STEP 5

Pour or pipette the correct amount (see Table 5-2, page 18) of warm agarose (< 60° C) onto the UVT gel tray that has been placed in the casting position in the buffer chamber. Immediately after pouring, insert the desired comb or combs into the comb slots to form the sample wells. If only a small portion of gel is required for proper sample separation, multiple combs may be used to run 2 sets of equal distance samples simultaneously expanding the number of samples per gel that may be run. Multiple sample loading configured for use with an 8 channel pipette is available by using the multi load tray (see page 24).

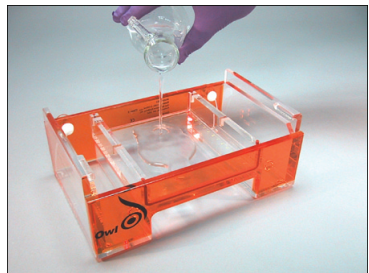

To conserve agarose, a wall comb may also be used to divide and use a smaller portion of the length of the gel tray. If a wall comb is used, pipette a bead of agarose along the bottom and side edges of the wall comb once it has been placed in the tray to seal the combs edges to the trays bottom and sides. Once this bead is solidified the cooled gel may be poured as described. Alternately, regular tape cut slightly longer than the comb can be placed flat along the combs surface and the comb angled into place in the gel tray. Extra tape is then placed on the outside of the comb in the excess tray area to reinforce the corners. Allow the gel to solidify completely.

Migration Distance

- Run one sample set on a gel in each tray
- Run two sample sets on a gel of equal length (comb slots) in each tray
- Run three sample sets on a gel of equal length samples (comb slots) in each tray
- Run four sample sets on a gel of equal length samples (comb slots) in each tray and so on up to 12 rows

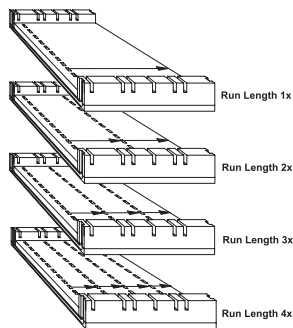

The following charts show the specific tray options for each model.

MODEL B1A

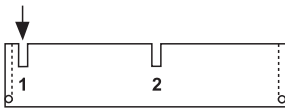

One comb for a 7.3cm run length

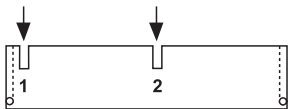

Two combs for two 3.6cm run lengths

MODEL B1

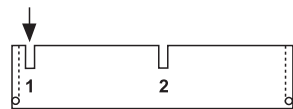

One comb for a 10cm run length

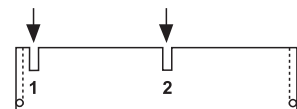

Two combs for two 4.9cm run lengths

MODEL B2 & B3

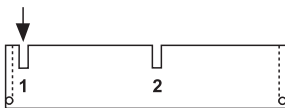

One comb for a 12.9cm run length

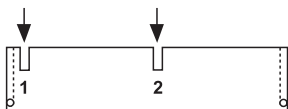

Two combs for two 6.3cm run lengths

STEP 1

1. Once the gel is completely solidified, lift the tray out of the chamber, turn it 90° in the running position (see page 9), and replace it in the chamber with the first comb closest to the cathode side of the chamber. This running position exposes the open ends of the agarose to the buffer. Standard agarose should solidify completely in about 30 minutes. If low melting point or a speciality agarose is used, consult the instructions that came with the product.

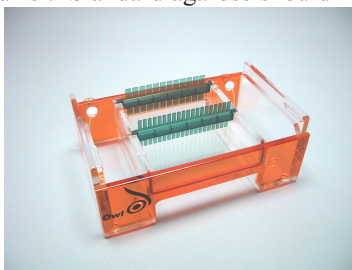

STEP 2

Pour enough compatible running buffer into the unit to fill the buffer chamber and completely cover and submerge the gel. Correct buffer level is clearly marked on the units side wall as “FILL LINE”. See Recommended Running Conditions for approximate buffer volumes needed for your unit. Too little buffer may cause the gel to dry out during the run, while excess buffer may decrease DNA mobility and cause band distortion.

STEP 3

Carefully remove the comb (or combs) by tapping lightly to loosen, and slowly lifting straight up out of the gel tray to avoid damage to the wells.

STEP 4

Loading the Sample in Gel

Wet loading - loading the sample in the gel when it is submerged in buffer.

- a. Place the gel tray into the buffer chamber in the running position.
- b. Pour running buffer into the unit to fill chamber and completely cover and submerge the gel.
- c. Load prepared samples into the wells. Samples should be mixed with a sample loading buffer; giving weight to the samples so that they drop evenly into the wells, and contain tracking dye to monitor the gel run.

NOTE: Load prepared samples into the wells. Samples should be mixed with a sample loading buffer; giving weight to the samples so that they drop evenly into the wells and containing tracking dyes to monitor the gel run. See available comb section for approximate well volumes (Comb Options page 27 & 28).

GASKET

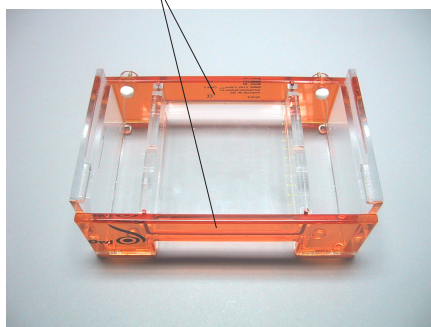

CASTING POSITION

GASKET

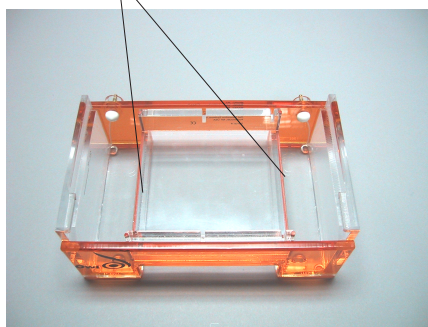

RUNNING POSITION

NOTE: It is wise to always run a sample lane of a known “standard ladder” to determine concentration and size of separated fragments after the gel run, and to aid in photo documentation and analysis (see page 12).

STEP 5

Carefully slide the SuperSafe™ lid with attached power supply leads onto the unit. This will connect the power cords to the banana plug electrodes. Plug the other end of the power supply leads into an appropriate power supply, completing the circuit. The gel is now a gesister in the circuit.

STEP 6

Turn on power supply. Refer to Table 3-1, for running conditions. Carefully monitor the gel run to avoid samples running into the path of another set of samples.

**Table 3-1,
Specifications and Recommended Running Conditions**

Model	B1A	B1	B2	B3
Gel Size (w x L in cm.)	7X8	9X11	12X14	12X14
Buffer Capacity	400ML	600ML	800ML	1000ML
Voltage Requirements (V)	20-150	20-150	20-150	20-150
Time Requirements (min.)	30-60	45-90	60-120	60-120

Model B3 Buffer Puffer™ Self Recirculation System

The Model B3 Buffer Puffer™ Self Recirculation System has a unique built in recirculating system designed to self recirculate buffer. Bubbles are collected at the cathode end of the unit and shunted through a conduit tube from the cathode end of the buffer chamber to the anode end of the buffer chamber. The bubbles displace buffer creating an effective recirculation within the chamber.

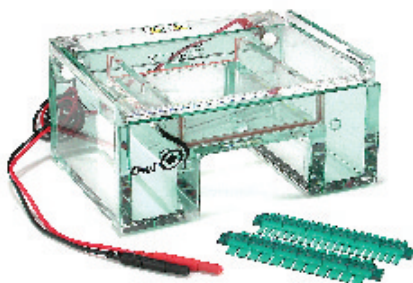

The Buffer Puffer™ self recirculating system reduces formation of pH gradients for high resolution and uniform, reproducible results. The self contained recirculation system requires no external pumps, tubing or stir bars. As shown in the diagram, a trap at the cathode end of the buffer chamber (1) collects the hydrogen bubbles produced at the electrode during electrophoresis. The bubbles are then shunted into a conduit tube (2) to the anode end of the chamber. This flow of bubbles displaces buffer (3) to create an internal recirculation system.

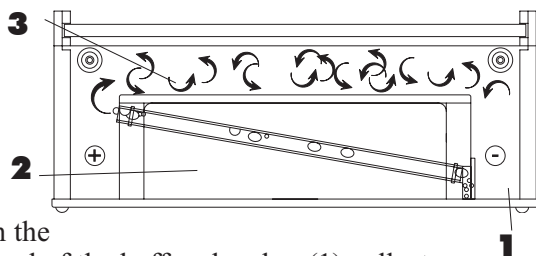

Instructions for Buffer Puffer™:

Priming the Unit

Fill the Buffer Puffer chamber with enough buffer to fill both compartments, and allow it to stand for about 15 minutes prior to running. Fill the chamber at the cathode end (black electrode) first. This will flush out trapped air in the hydrogen collector and recirculation tube.

Priming the unit is most important when using buffers of low ionic strength (like TAE or NaPO₄). This process minimizes the electro-static repulsion between the hydrogen gas bubbles and the recirculation tube's surface. Neglecting this step may result in decreased efficiency of the recirculation system. Refer to General Instructions section of this manual for use following this priming step.

STEP 1

When the gel run is complete and tracking dye has migrated as far through the gel as desired, or to the end of the gel, turn off the power supply and slide off the SuperSafe™ lid to disconnect from the power source. Carefully remove the tray containing the gel (wear gloves if ethidium bromide is present). The UV Transmissible (UVT) gel tray makes visualization and photography with a UV light source easy without the need to remove the gel from the tray.

STEP 2

The buffer chamber, SuperSafe™ lid, UVT gel tray and combs should be rinsed under warm running water after each use. An RNase/DNase decontaminate may be used. **This electrophoresis system must never be autoclaved, baked, or microwaved!**

Running a Standard Ladder

It is recommended to always run a sample lane of a known “standard ladder” or “marker” to determine concentration and size of separated fragments after the gel run, and to aid in photodocumentation and analysis. Migration patterns and fragment sizes for commonly used DNA molecular weight markers are shown in this figure.

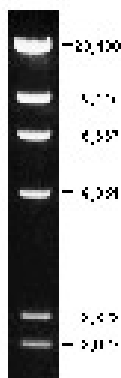

Loading Samples

It is sometimes easier to load the sample wells dry before placing buffer into the buffer chamber. After the gel solidifies, if cast within the buffer chamber, remove the gel tray from the buffer chamber and place the tray on the lab bench. Carefully remove the sample combs by tapping and lifting straight up. Samples mixed with loading buffer that does not contain dye may be easier to load dry, especially in larger gel units to avoid cross contamination. After loading all sample lanes, place the gel tray into the buffer chamber in the running position with the gel edges facing out toward the buffer chambers with the gasketed end gates removed and slowly fill the chamber with buffer.

Comb Options

Standard

1.0mm and 1.5mm thickness: for all models.

Combs are hand fabricated for high quality precision in low volumes. Each comb has an acrylic spine with Lexan® teeth.

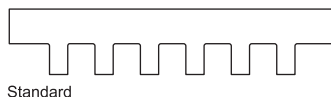

Standard

Double Sided

Double Sided Molded Combs combine 1.0mm and 1.5mm tooth thickness on one comb. Double sided combs provide greater precision due to the exact manufacturing technique which provides greater control over tooth size and spacing than the traditional machining methods. The number of teeth and arrows that point to the designated thickness is molded onto the spine for easy identification. A raised section of the spine helps the user grip the comb when removing it from the gel. Owl's combs are molded from durable polycarbonate that holds up through years of use.

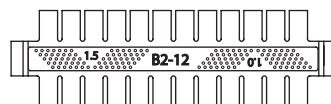

Double Sided

Preparative

Preparative combs are manufactured with an acrylic spine and Lexan® teeth. Used for extremely large samples.



Preparative

Multi Load Comb

For use with 8-12 channel pipettes.

These unique combs are designed to allow accurate easy loading from a 96 well plate.



Multi-Load Comb

Custom Combs

Call Owl Customer Service for more information, 800-242-5560.

Wall Comb

The wall comb is used in your existing U.V. Transmissible (UVT) gel tray to allow the ability to cast smaller gels using the existing gel tray and the comb slots. There are various ways to use the wall comb to ensure a leak proof seal. These two are the fastest and easiest.



Wall Comb

Tape Method

Using casting tape, transparent tape, or masking tape, cut a piece long enough to cover the full length of the wall comb with about 1/2" overhang at each end. Half the width of the tape should be free. Firmly press the tape all along the comb leaving the three open edges loose. Place the comb with tape into the gel tray at the desired comb slot position. The taped side of the comb should be facing away from where the gel will be cast. Angle the comb as it is being placed into the comb slot so the loose taped edge is free. Once positioned into the gel tray, firmly press the tape to the bottom and sides of the gel tray to form a leakproof seal. Small extra pieces of tape may be added to the corners afterwards to reinforce the edges. Add cooled (<math><60^\circ</math>), slightly thickened agarose to the gel tray and allow to solidify completely. To remove comb, gently remove excess tape and loosen tape from the bottom and sides of the gel tray. Carefully pull comb straight up and out of the comb slot.

Note: The edge of the gel may appear irregular, once submerged in running buffer the gel run will be unaffected.

Agarose Plug Method

Place the wall comb into the desired comb slot. Prepare agarose as usual and remove about 3ml to a test tube. Allow this aliquot to cool and thicken enough to make a thin partially solid worm of agarose. Using a Pasteur pipette or other transfer device, gently place a small stream of agarose all along the three comb edges at the bottom of the gel tray and sides to form a leakproof seal. Allow "plug" to solidify completely checking that all exposed areas are filled in with agarose. Next, add cooled agarose (<math><60^\circ</math>) to the gel tray. After the gel is completely solidified; rock the comb back and forth slightly to loosen it when removing to avoid damage to the gel. Adding running buffer to the buffer chamber prior to removing comb(s) may make the comb removal easier.

Helpful Tips

- Cooling the agarose slightly more than usual will help eliminate leaking because the gel thickens as it solidifies and is less likely to leak. To avoid visible solids due to uneven cooling, gently swirl the agarose. Exact temperature of the agarose depends on the type used, but the gel should be thickened yet still evenly liquid so it is pourable and consistent.
- Gels of higher concentrations (>0.5%) are also easier to work with, especially when using the agarose plug method.

Micro Well Format Combs

Micro well format combs, available with many Owl horizontal and sequencing devices, are meant to be used in conjunction with an 8- or 12- channel pipette. The pipette is manufactured to be used with a 96 well (8 wells wide x 12 wells long) multichannel plate. The key here is the constant distance of 9mm between the center of each well in the multichannel plate. The multichannel pipette is set up so that the pipette tips are exactly 9mm apart, and a researcher can take up 8 (or 12) samples simultaneously from the plate.

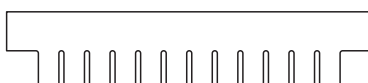

Micro Well Format 1x



Micro Well Format 2x

To be able to load these samples simultaneously onto a gel, the “center to center” distance between sample wells in the gel must be exactly 9mm. The micro well format comb that would give this exact distance would be a 1x micro well format comb. However, the ability to space wells exactly 9mm apart is dependent on the total width of the gel and the number of sample wells that the researcher wants in the gel.

There are four options that fit the use of a 9mm “center to center” pipette tip format. The 9mm spacing represents a 1x option micro well format. By decreasing the center to center distance in factors of 9mm, one can fit more samples in a given amount of space with the ability to use the same micro well format pipette. The 2x is 9 divided by 2, the 3x is 9 divided by 3 and the 4x is 9 divided by 4.

Therefore, it is possible to have a greater number of teeth in a comb and maintain the use of the multichannel pipette, by having the multichannel pipette fill every other well rather than every well. This type of multichannel pipette format comb is called a 2x multichannel pipette format comb. For example, the 50 tooth comb for the A6 device has “center to center” distances between teeth of 4.5cm. This means that a researcher would load lanes 1,3,5,7,9,11,13, and 15 with the first pass of the pipette and 2,4,6,8,10,12,14 and 16 with the second pass, and so on until all of the lanes are filled.

When using an 8 (or 12) channel pipette, the number of sample wells that can be filled must be a multiple of 8 (or 12). A 25 well micro well format comb would have one extra sample and a 50 well micro well format comb would have 2 extra samples, which a researcher could fill with a single channel pipette, and is generally used for standards.

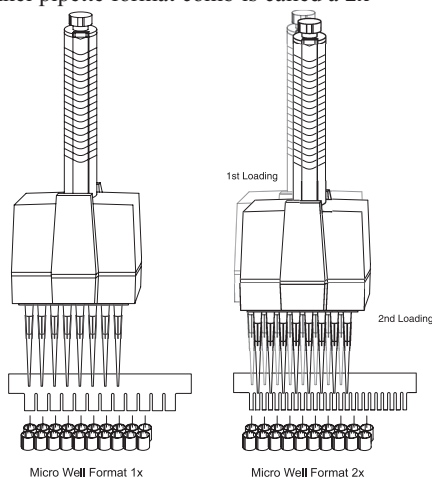

Why Recirculate Buffer?

During electrophoresis, gradual ionic depletion of the running buffer forms an ionic and pH gradient across the system (acetate and phosphate buffers are especially prone to ionic depletion). Such gradients can cause uneven migration and banding patterns or cause pH-dependent glyoxylated RNA molecules to disassociate. Buffer recirculation ensures uniform ionic strength throughout the system.

Comparison of buffer pH with and without recirculation during agarose gel electrophoresis

50ng samples of HindIII digested DNA were run on duplicate gels, with and without buffer recirculation. pH measurements were taken at the anode and cathode ends at various time intervals and plotted against time. Running condition: 1% agarose gel in 10mM NaH₂PO₄, pH 7.0, 114V, constant voltage.

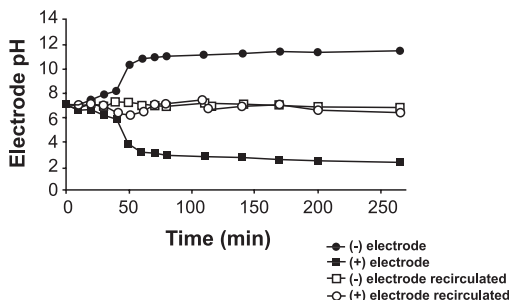

Sample Well / Comb Configuration

Hg = height of gel used

Hs = height of well used for sample volume

Hw = well height

How to determine well sample volume:

There are two volumes to consider when determining the sample volume for a horizontal gel. 1) Gel volume, which is Width x Length x Gel Height and uses centimeters and 2) Sample volume which is Tooth Width x Comb Thickness x Apparent Well Height, and uses millimeters.

Gel height is generally set to a height between 0.25 cm and 1.0 cm. Therefore, once you choose the height, the volume is the gel dimensions given in the catalog for each gel box (I.D.) times this height. Once the gel height (Hg) is chosen, the well volume and then the sample volume can be calculated. The well height (Hw) is 1.5 mm less than the gel height: $H_w = \text{Gel Height} - 1.5 \text{ mm}$. Using the well height, the volume of the well is calculated: $V_w = (\text{Well Height}) (\text{Tooth width} \times \text{comb thickness})$. The loading volume is a 0.75 safety factor applied to the well volume: $V_s = (V_w) (.75)$

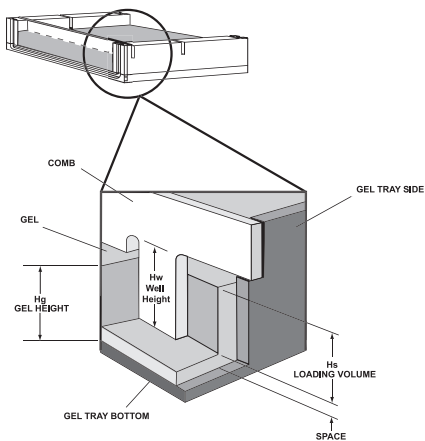

For Owl combs, there are two thicknesses, 1.0mm and 1.5mm. This is the depth. The width of the well is determined by the number of teeth. For a given gel box, as the number of teeth increase, the volume of each tooth decreases.

Reagent Information

There are various types of agarose commercially available that may be used. Besides standard ultra pure electrophoresis grade agarose, there are also numerous low melting point products for easy sample recovery, as well as speciality products formulated for specific uses to separate/recover very small or very large fragments etc.

To visualize and photograph the samples after the gel run for a permanent record, the gel may be stained during or following the run with a variety of stains. The most common stain for DNA is ethidium bromide. Ethidium bromide may be added directly to the gel and running buffer to quickly and easily visualize and photograph the separated fragments following the gel run without the need for additional staining. If this is not added, then following the gel run the gel may also be soaked in a concentrated ethidium bromide solution and rinsed for the same visualization. The ethidium bromide is added to both the gel (after heating) and the electrophoresis buffer at a concentration of 0.5 μ g/ml.

Ethidium bromide is a potential carcinogen. Care in handling the powder and stock solution must be taken. Always wear gloves when handling the powder, solutions and all gels that contain any amount of ethidium bromide.

Table 5-1, Mobility range of DNA in different percentage agarose gels

Agarose % (w/v)	Approximate range of separated DNA fragments (kb)
0.3	60 to 5
0.5	30 to 1
0.7	12 to 0.8
1.0	10 to 0.5
1.2	7 to 0.3
1.5	4 to 0.2
2.0	3 to 0.1
3.0	< 0.1

It should be noted, an increased agarose % gives better separation of small fragments and also bands very close together that tend to be more difficult to separate, visualize and photograph. A speciality agarose product formulated to increase resolution of low molecular mass samples may also be used.

Example: A good mid range gel percentage would be 0.7%, or 0.7g agarose in 100mls electrophoresis buffer (TBE or TAE), following heating and dissolving the agarose, 10 μ l of ethidium bromide stock solution (5mg/ml) is added. The gel would be run with compatible electrophoretic running buffer (1X TBE or 1X TAE) that also contained ethidium bromide 1 liter of the running buffer would contain 100 μ l of this 5mg/ml ethidium bromide stock solution.

Preparation & Properties of TAE and TBE Electrophoresis Buffer Systems:

These buffers are used because they both have a basic pH which gives the phosphate group of the DNA a net negative charge allowing migration of the DNA toward the positive anode in the electrophoresis chamber.

TAE - Tris acetate with EDTA (40mM Tris base 40mM acetic acid, 1mM EDTA)

50X stock solution, pH ~8.5:

242g Tris base

57.1ml glacial acetic acid

18.61g Na₂EDTA - 2H₂O (MW 372.24)

Distilled H₂O to 1 liter final volume

1X working solution:

40mM Tris acetate

1mM EDTA

TBE - Tris borate with EDTA (89mM Tris base, 89mM boric acid, 2mM EDTA)

10X stock solution:

108g Tris base

55g boric acid

7.44g Na₂EDTA - 2H₂O (MW 372.24)

(or 40 ml 0.5 M EDTA, pH 8.0)

Distilled H₂O to 1 liter final volume

Do not adjust pH

1X working solution:

89mM Tris base

89mM boric acid

2mM EDTA

Buffer:

TAE Buffer

Suggested Uses and Comments:

Use when DNA is to be recovered

For electrophoresis of large (>20kb) DNA

Applications requiring high resolution

Has low ionic strength and low buffering

capacity - recirculation may be necessary
for long runs (>4hrs.)

TBE Buffer

For electrophoresis of small (<1kb) DNA

Better resolution of small (<1kb) DNA

Decreased DNA mobility

High ionic strength and high buffering

capacity - no recirculation needed for
extended run times

TBE buffer reacts with the agarose making smaller pores and a tighter matrix. This reduces broadening of the DNA bands for sharper resolution.

Ethidium Bromide -

Ethidium bromide is ideal for the fluorometric detection of nucleic acids in gel electrophoresis. The addition of ethidium bromide to both the prepared gel and running buffer is a convenient way to monitor separation and keep a photographic log of gel runs. Ethidium Bromide is prepared as 10mg/ml in distilled water and used as a stock working solution of 5.0 μ g/ml in the electrophoresis buffer and gel. Mix ethidium bromide powder or tablet thoroughly into solution checking for any precipitate and store at room temperature protected from light.

Amount of Agarose to prepare:

Gel volume is determined by the following formula and may be adjusted according to need or preference:

Table 5-2, Amount of Agarose

gel width(cm) X gel length (cm) X gel thickness (cm) = ml of agarose

Model #	Gel size(cm)	Agarose Volume in ml per gel thickness in cm.			
		0.25cm	0.5cm	0.75cm	1.0cm
B1A	7 X 8	14ml	28ml	42ml	56ml
B1	9 X 11	25ml.	50ml.	74ml.	99ml.
B2	12 X 14	42ml.	84ml.	126ml.	168ml.
B3	12X14	42ml.	84ml.	126ml.	168ml.

Agarose Gel Loading Buffer

Samples are prepared and combined with gel loading buffer before being applied to the prepared gel. Sample buffer usually contains similar components to the running buffer, dyes for visibility, and glycerol to provide some weight to the samples. This increased sample density and color allows easy visualization of the samples and ensures samples load evenly into the wells and do not float out during loading. Dyes also migrate toward the anode end of the electrophoresis chamber at predictable rates allowing the gel run to be monitored.

The most commonly used loading buffer is glycerol, bromophenol blue, and xylene cyanol.

PROBLEM	SOLUTION
Agarose leaks into chamber when casting the gel	<p>Check to see if the gasket is correctly seated in groove and even all the way around. Remove gasket and reseal by smoothing it out gently with your thumb from one end to the other. After each use rinse the gel tray under warm running water. Please contact Owl to purchase replacement gaskets.</p> <p>Check to make sure gasketed end of the gel tray have been placed with the gaskets facing the sides of the buffer chamber</p>
Bands seem to be running at an angle.	Check to be sure that the unit is properly leveled for casting and running the gel. Owl offer a leveling platform, BP-LP, see page 25. Always center the gel tray in the buffer chamber and cool the agarose to below 60°C before pouring to avoid warping the UVT gel tray (s).
Samples seem to be running unevenly in certain areas.	Check that the platinum electrode wire is intact running flat and evenly across the outer corners and up the side to the junction of the banana plug area. This problem could also be caused by regular casting with very hot agarose gel (>60°C) which may damage the gel tray over time. Always cool the melted agarose to below 60°C before casting to avoid warping the UVT gel tray. Warping the UVT gel tray will cause all subsequent gels to be cast unevenly.

PROBLEM	SOLUTION
Samples do not band sharply and appear diffuse in the gel.	Gels should be allowed to solidify completely before running. For standard agarose this would be about 30 minutes, if low melting point agarose is used it may be necessary to completely solidify gels at a cooler temperature in the refrigerator or cold room. Gels should be submerged in 3-5mm of buffer to avoid gel dry out, but excess buffer >5mm can cause decreased DNA mobility and band distortion.
Bands are not sharp, clear, and even.	Always follow the proper procedure for preparing the agarose product according to the manufacturer's instructions. When preparing the agarose be sure all the agarose powder is in solution before heating. In general, add powdered agarose to distilled water and swirl to mix. Make sure all the powder is equally wet to ensure proper melting. Heat in a microwave oven, boiling water bath, or hot plate with occasional swirling to melt and mix completely. Cool agarose liquid to below 60° and cast. Note: High percentage gels may thicken and solidify rapidly and should be cast while still a liquid.
Samples are not moving as expected through the gel, remaining in the wells, or diffusing into the gel.	Check that a complete power circuit is achieved between the unit and the power supply. Platinum wire and banana plugs should be intact. To test, simply fill the unit with running buffer and attach to the power supply without a gel or gel tray in the unit. The platinum wires on both sides of the unit should produce small bubbles as the current passes through. If a complete circuit does not exist there will be few to no bubbles. Contact Owl's Customer Service Dept. to schedule a repair.

PROBLEM	SOLUTION
When the comb is removed from the gel some sample wells are ripped and damaged.	Always make sure to allow the gel to solidify completely before moving the gel tray, unit, or removing the comb. To avoid damage to the sample wells, gently rock the comb back and forth lightly to loosen, then slowly pull the comb straight up out of the gel tray. This rocking helps to avoid suction as the comb is removed. Alternatively, once casting is complete, simply submerging the gel with running buffer will help loosen the comb. Using a higher percentage of agarose that forms a tighter gel matrix may remedy this problem as well.
The gel seems to run slower under the usual running conditions.	The volume of running buffer used to submerge the gel should only be between 3-5mm over the gel surface. Gel should be completely submerged to avoid the gel from drying out, which can smear the bands and possibly melt the gel (s) due to overheating. If excessive running buffer is added the mobility of the DNA decreases and band distortion may result. Excess buffer causes heat to build up and buffer condensation inside the unit may result.

Additional Sources for Reference

Maniatis T., E. F. Fritsch and J. Sambrook. ***Molecular Cloning: A Laboratory Manual***, Cold Spring Harbor Laboratory, Cold Spring Harbor, NY.

Short Protocols in Molecular Biology, - A Compendium of Methods from Current Protocols in Molecular Biology, Edited by Fredrick M. Ausubel, et. al.

Adams, D., and R. Ogden, ***Electrophoresis in Agarose and Acrylamide Gels, Methods in Enzymology***, Vol. 152 (1987) Academic Press, Inc.

Fotador, U.. ***Simultaneous Use of Standard and Low-Melting Agarose for the Separation and Isolation of DNA by Electrophoresis***, BioTechniques, Vol. 10, No. 2, (1991)

Boots, S. ***Gel Electrophoresis of DNA*** ; Analytical Chemistry, Vol. 61, No. 8, April 15, 1989

A Few Tips About Caring for Your System

WARNING!

Organic solvents cause acrylic to “craze” or crack. Clean all Owl acrylic systems with warm water and a mild detergent. Do not use ethanol or other organic solvents to clean Owl products. Do not autoclave, bake, or microwave your unit. Temperatures over 50°C can do damage to the acrylic.

NOTE:

If an RNase free electrophoresis system is desired, there are various methods to rid the system of RNA contamination. For fast and easy decontamination, use RNase Away®*. Spray, wipe or soak labware with RNase Away® then wipe or rinse the surface clean; it instantly eliminates RNase. RNase Away® eliminates the old methods that include treatment with 0.1% Diethyl Pyrocarbonate (DEPC) treated water and soaking in dilute bleach. DEPC is suspected to be a **carcinogen** and should be handled with care. This electrophoresis system should never be autoclaved, baked, or placed in a microwave.

To order RNase Away®, contact Molecular BioProducts at 800-995-2787 (U.S. and Canada) or 858-453-7551:

Part Number

7000	250ml bottle
7002	475ml spray bottle
7003	1 liter bottle
7005	4 liter bottle

**Rnase AWAY® is a registered trademark of Molecular BioProducts*

Care of Acrylic

The following chemical compatibility chart is supplied for the convenience of our customers. Although acrylic is compatible with most solvents and solutions found in the biochemical laboratory, some solvents can cause substantial damage. Keep this chart handy to avoid harm to your apparatus by the use of an inappropriate solvent.

Codes:

S—Safe (No effect, except possibly some staining)

A—Attacked (Slight attack by, or absorption of, the liquid)

(Slight crazing or swelling, but acrylic has retained most of its strength)

U—Unsatisfactory (Softened, swollen, slowly dissolved)

D—Dissolved (In seven days, or less)

Table 7-1 Chemical Compatibility for Acrylic-Based Products

Chemical	Code	Chemical	Code	Chemical	Code
Acetic acid (5%)	S	Ethyl alcohol (50%)	A	Naptha	S
Acetic acid (Glacial)	D	Ethyl alcohol (95%)	U	Nitric acid (10%)	S
Acetic Anhydride	A	Ethylene dichloride	D	Nitric acid (40%)	A
Acetone	D	Ethylene glycol	S	Nitric acid concentrate	U
Ammonia	S	2-Ethylhexyl Sebacate	S	Oleic acid	S
Ammonium Chloride (saturated)	S	Formaldehyde (40%)	S	Olive oil	S
Ammonium Hydroxide (10%)	S	Gasoline, regular, leaded	S	Phenol 5% solution	U
Hydroxide (10%)	S	Glycerine Heptane (commercial grade)	S	Soap solution (Ivory)	S
Ammonium Hydroxide concentrate	S	Hexane	S	Sodium carbonate (2%)	S
Aniline	D	Hydrochloric acid (10%)	S	Sodium carbonate (20%)	S
Benzene	D	Hydrochloric acid concentrate	S	Sodium chloride (10%)	S
Butyl Acetate	D	Hydrofluoric acid (40%)	U	Sodium hydroxide (1%)	S
Calcium chloride (saturated)	S	Hydrogen peroxide (3% solution)	S	Sodium hydroxide (10%)	S
Carbon tetrachloride	U	Hydrogen peroxide (28% solution)	U	Sodium hydroxide (60%)	S
Chloroform	D	Isooctane	S	Sodium hydrochlorite (5%)	S
Chromic acid (40%)	U	Isopropyl alcohol (100%)	A	Sulfuric acid (3%)	S
Citric acid (10%)	S	Kerosene (no. 2 fuel oil)	S	Sulfuric acid (30%)	S
Cottonseed oil (edible)	S	Lacquer thinner	D	Sulfuric acid concentrate	U
Detergent Solution (Heavy Duty)	S	Methyl alcohol (50%)	A	Toluene	D
Diesel oil	S	Methyl alcohol (100%)	U	Trichloroethylene	D
Diethyl ether	U	Methyl Ethyl Ketone	U	Turpentine	S
Dimethyl formamide	U	Methylene chloride	D	Water (distilled)	S
Dioctyl phthalate	A	Mineral oil (white)	S	Xylene	D
Ethyl acetate	D				

This list does not include all possible chemical incompatibilities and safe compounds. Owl's acrylic products should be cleaned with warm water, a mild detergent such as Alconox™, and can also be exposed to a mild bleach solution (10:1). In addition, RNAse removal products are also safe for acrylic. Please contact Owl's Technical Service at 1-800-242-5560 with any questions.

Multi-Load Tray & Combs

Multiple sample loading configured for use with an 8 channel pipette is available by using the multi load tray (B2-RL) and combs (B2-RL-9D).

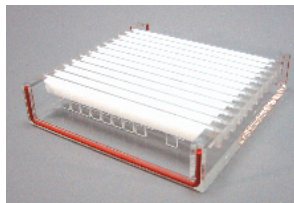

Multiple Gel Caster

Pour multiple gels while the buffer chamber is in use. EasyCast™ UVT gel trays fit snugly between the walls of the heavy duty gel caster (B1A-CST, B1-CST & B2-CST). Additional EasyCast™ UVT gel trays and combs are sold separately.

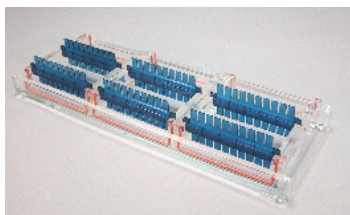

Buffer Exchange Port Option, for Models B1A, B1, and B2

The buffer exchange port option is used to recirculate the buffer during extended gel runs. Recirculation is used to prevent buffer depletion of certain low ionic running buffers, for extended runs, multiple sample sets, or for RNA gels. If your unit has the buffer exchange port option it will be fitted with two white buffer port terminals and will contain two separate port inserts packaged in a small plastic bag located inside the unit upon arrival. Ports are attached to a user supplied pump.

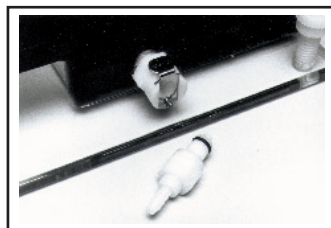

How these work...

The inserts are pushed into the attached ports on the side wall of the unit with the black O-ring side facing in. The insert will “snap” into place in the port in the “open” position and is ready to circulate buffer. Appropriate tubing is then connected to the small outer ringed ends of the ports for circulation using a separate recirculator or peristaltic pump. To close the port, which also releases the insert, you simply press the flat metal button and the insert detaches. The port is now in the “closed” position.

NOTE: Buffer may also be passed through a heat exchanger.

Leveling Platform

The three point leveling platform, Model B-LP, ensures a flat casting and running surface. The platform is 46cm x 36cm and is large enough to fit most applications. One bubble level (BBL-1) is included.



Replacement Parts

Contact the customer service department at Owl to order replacement parts at 800-242-5560.

B1A Replacement Parts

Item Description	Catalog No.
Complete System	B1A
Complete System with Buffer Exchange Ports	B1A-BP
Accessories	Catalog No.
Power Supply Leads	PSL-5
Gasketed EasyCast™ UVT Gel Tray	B1A-UVT
Replacement Gaskets (1 pair)	B1A-GK
External Caster (trays not included)	B1A-CST
Leveling Platform (36cmW x 46cmL)	B-LP
Bubble Level	BBL-1

B1 Replacement Parts

Item Description	Catalog No.
Complete System	B1
Complete System with Buffer Exchange Ports	B1-BP
Accessories	Catalog No.
Power Supply Leads	PSL-5
Gasketed EasyCast™ UVT Gel Tray	B1-UVT
Replacement Gaskets (1 pair)	B1-GK
External Caster (trays not included)	B1-CST
Leveling Platform (36cmW x 46cmL)	B-LP
Bubble Level	BBL-1

B2 Replacement Parts

Item Description	Catalog No.
Complete System	B2
Complete System with Buffer Exchange Ports	B2-BP
Accessories	Catalog No.
Power Supply Leads	PSL-5
EasyCast™ Gasketed UVT Gel Tray	B2-UVT
EasyCast™ Gasketed Multi Load UVT Gel Tray 12 Slots	B2-RL-UVT
EasyCast™ Gasketed Multi Load UVT Gel Tray 12 Slots with 12 Combs (B2-RL-9D)	B2-RL
Replacement Gaskets (1 pair)	B2-GK
External Caster (trays not included)	B2-CST
Leveling Platform (36cmW x 46cmL)	B-LP
Bubble Level	BBL-1

B3 Replacement Parts

Item Description	Catalog No.
Complete System	B3
Accessories	Catalog No.
Power Supply Leads	PSL-5
EasyCast™ Gasketed UVT Gel Tray	B2-UVT
EasyCast™ Gasketed Multi Load UVT Gel Tray 12 Slots	B2-RL-UVT
EasyCast™ Gasketed Multi Load UVT Gel Tray 12 Slots with 12 Combs (B2-RL-9D)	B2-RL
Replacement Gaskets (1 pair)	B2-GK
External Multiple Casting Chamber (trays not included)	B2-CST
Leveling Platform (36cmW x 46cmL)	B-LP
Bubble Level	BBL-1

Comb Options – Model B1

Catalog Number	Comb Type	Number of Teeth	Thickness of Teeth	Width of Teeth	Recommended Loading Volumes ¹			
					0.25cm ²	0.5cm ²	0.75cm ²	1.0cm ²
B1-5C	Standard	5	1.0mm	15.4mm	12ul	40ul	69ul	99ul
B1-5D	Standard	5	1.5	15.4	17	61	104	147
B1-8C	Standard	8	1.0	9.0	7	24	41	57
B1-8D	Standard	8	1.5	9.0	10	35	61	86
B1-10	Double	10	1.0	6.8	5	18	31	43
	Sided		1.5	6.8	8	27	46	65
B1-12C	Standard	12	1.0	5.4	4	14	24	34
B1-12D	Standard	12	1.5	5.4	6	21	36	52
B1-14	Double	14	1.0	4.4	3	12	20	28
	Sided		1.5	4.4	5	17	30	42
B1-PREP	Prep	2	1.5	78/5	90/6	310/19	525/32	750/46
XCM	Custom		1.0, 1.5 2.0, 3.0					

¹ Loading Volume is calculated as 75% of total well volume (see page 15)

² Gel Thickness

Comb Options – Model B2 & B3

Catalog Number	Comb Type	Number of Teeth	Thickness of Teeth	Width of Teeth	Recommended Loading Volumes ¹			
					0.25cm ²	0.5cm ²	0.75cm ²	1.0cm ²
B2-8C	Standard	8	1.0mm	12.5mm	9 ul	33 ul	56 ul	80 ul
B2-8D	Standard	8	1.5	12.5	14	49	84	120
B2-12 ³	Double	12	1.0	7.2	5	18	32	46
	Sided		1.5	7.2	8	28	49	69
B2-16	Double	16	1.0	5.4	4	14	24	34
	Sided		1.5	5.4	6	21	36	52
B2-20	Double	20	1.0	3.9	3	10	18	25
	Sided		1.5	3.9	4	15	26	37
B2-24	Double	24	1.0	3.0	2	8	14	19
	Sided		1.5	3.0	3	12	20	29
B2-RL-9D ³	Micro Well	9	1.5	7.2	8	28	49	69
B2-PREP	Prep	2	1.5	106/5	120/5.5	415/20	710/34	1000/48
B2-WALL	Wall	1	1.5	120				
XCM	Custom		1.0, 1.5, 2.0, 3.0					

¹ Loading Volume is calculated as 75% of total well volume (see page 15)

² Gel Thickness

³ 8 & 12 Channel Pipette Format

Comb Options – Model B1A

Catalog Number	Comb Type	Number of Teeth	Thickness of Teeth	Width of Teeth	Recommended Loading Volumes ¹			
					0.25cm ²	0.5cm ²	0.75cm ²	1.0cm ²
B1A-5C	Standard	5	1.0mm	11.3mm	8ul	30ul	51ul	72ul
B1A-5D	Standard	5	1.5	11.3	32	64	95	127
B1A-6	Double	6	1.0	9.1	17	34	51	68
	Sided		1.5	9.1	26	51	77	102
B1A-8	Double	8	1.0	6.4	12	24	36	48
	Sided		1.5	6.4	18	36	54	72
B1A-10	Double	10	1.0	4.7	9	18	26	35
	Sided		1.5	4.7	13	26	40	53
B1A-12	Double	12	1.0	3.7	7	14	21	28
	Sided		1.5	3.7	10	21	31	42
B1A-PREP	Prep	2	1.5	57/5	64/6	225/19	385/32	550/46
XCM	Custom	1.0, 1.5, 2.0, 3.0						

¹ Loading Volume is calculated as 75% of total well volume (see page 15)

² Gel Thickness

Warranty Information

THE OWL SEPARATION SYSTEMS WARRANTY

A three-year quality and material warranty covers all products manufactured by Owl Separation Systems. Owl will repair or replace any equipment found to be defective at no cost. This warranty does not cover equipment damage due to misuse or abuse. After the warranty expires, Owl will repair products at a reasonable cost. All shipping claims must be made within 48 hours from date received.

To activate your warranty, complete and return the enclosed postage paid warranty card. Please note that the card must be completely filled out in order to process your warranty.

RETURNING EQUIPMENT

Be environmentally friendly – and speed up your return – by saving all packing materials cartons and documents until you have thoroughly inspected your shipment. Should you find that your order is incorrect or damaged, verify the problem with the shipper, save all packing material, and call Owl for return instructions within 48 hours. All returns, exchanges, and credits must be pre-approved by Owl.

IMPORTANT DOCUMENTS ENCLOSED

Model #: _____

Serial #: _____

C.T.: _____



Separation Systems
55 Heritage Avenue
Portsmouth, NH 03801

T. (603) 559-9297

(800) 242-5560

F. (603) 559-9258

Website: www.owlsci.com

E-mail: sales@owlsci.com

Thank You!

We at Owl Separation Systems thank you for your order and appreciate your business. Please contact us regarding our complete line of electrophoresis equipment and reagents for DNA, RNA and protein separations. While innovation and quality are our foremost objectives, we pride ourselves on exceptional customer response and service.